

5

Thrust ball bearings



5 Thrust ball bearings

Designs and variants	467		
Single direction thrust ball bearings.....	467		
Double direction thrust ball bearings.....	467		
Bearings with sphered housing washers.....	468		
Cages.....	468		
Bearing data	469		
(Dimension standards, tolerances, permissible misalignment)			
Loads	469		
(Minimum load, equivalent dynamic bearing load, equivalent static bearing load)			
Temperature limits	470		
Permissible speed	470		
Mounting	470		
Designation system	471		
Product tables			
5.1 Single direction thrust ball bearings	472		
5.2 Single direction thrust ball bearings with a sphered housing washer	482		
5.3 Double direction thrust ball bearings	486		
5.4 Double direction thrust ball bearings with sphered housing washers	490		
		Other thrust ball bearings	
		Bearings with Solid Oil	1023
		NoWear coated bearings	1059
		Polymer ball bearings	→ skf.com/bearings

5 Thrust ball bearings

More information

General bearing knowledge	17
Bearing selection process	59
Lubrication	109
Bearing interfaces	139
Seat tolerances for standard conditions	148
Sealing, mounting and dismounting	193

SKF thrust ball bearings (fig. 1) are manufactured as single direction or double direction thrust ball bearings. They are designed to accommodate axial loads only and must not be subjected to any radial load.

Bearing features

- **Separable and interchangeable**
The separable components of SKF thrust ball bearings are interchangeable (fig. 2). This facilitates mounting and dismounting, and maintenance inspections.
- **Initial misalignment**
Bearings with sphered housing washer(s) (fig. 3) can accommodate initial misalignment.
- **Interference fit**
Shaft washers have a ground bore to enable an interference fit. The bore of the housing washer is turned and always larger than the shaft washer bore.

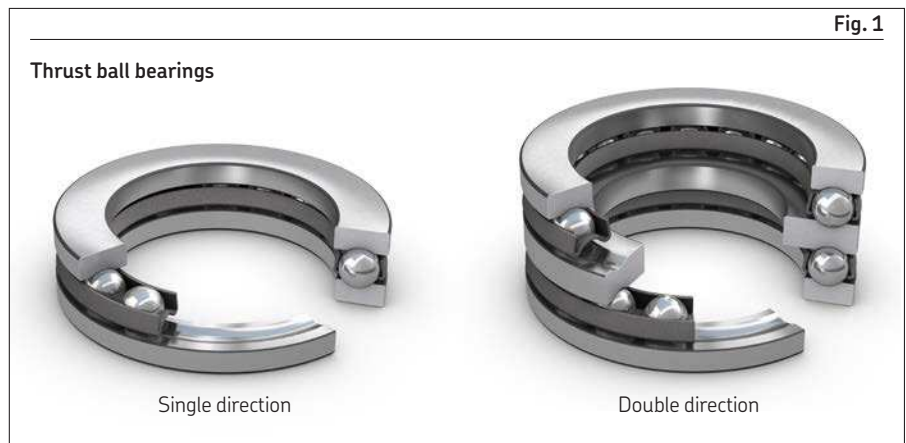

Designs and variants

Single direction thrust ball bearings

- consist of a shaft washer, a housing washer and a ball and cage assembly (fig. 4)
- can accommodate axial loads and locate a shaft axially, in one direction only

Double direction thrust ball bearings

- consist of one shaft washer, two housing washers and two ball and cage assemblies (fig. 5)
- The housing washers and ball and cage assemblies of double direction bearings are identical to those used in single direction bearings.
- can accommodate axial loads and locate a shaft axially, in both directions

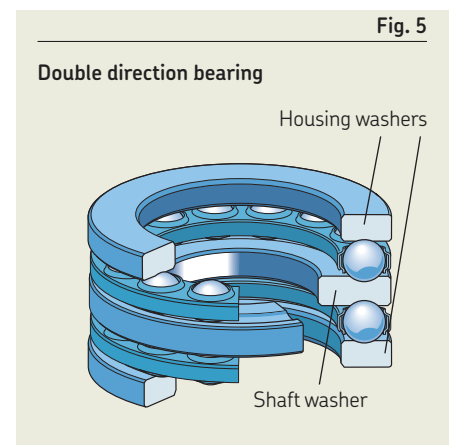
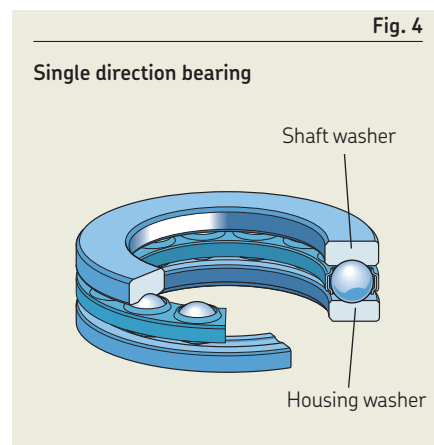
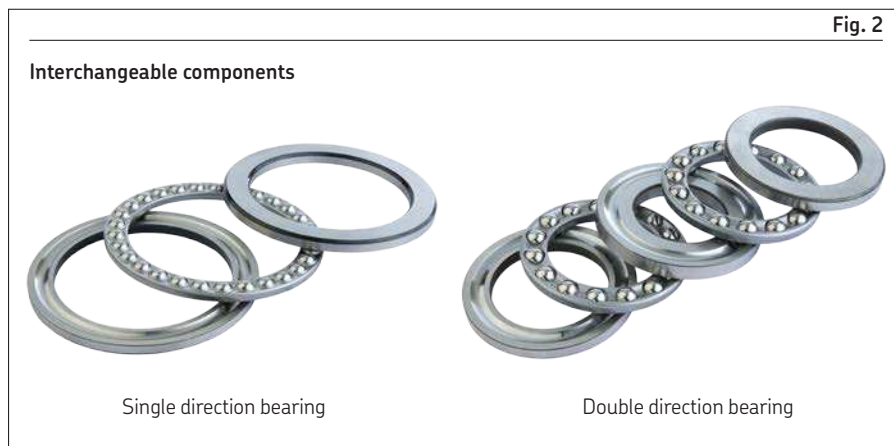

Bearings with sphered housing washers

- can accommodate initial misalignment
- are available in both single (fig. 6) and double direction designs
- can be used together with a sphered seat washer adjacent to the housing washer (fig. 7) or adjacent to a machine component manufactured with a sphered surface

Appropriate sphered seat washers must be ordered separately (product tables, page 482, and page 490). Depending on the bearing series, they have the basic designation U 2, U 3 or U 4 followed by a two-digit number, which identifies the size, e.g. sphered seat washer U 320 for bearing 53320.

Cages

SKF thrust ball bearings are fitted with one of the cages shown in table 1.

For additional information about the suitability of cages, refer to Cages, page 187.

Table 1

Cages for thrust ball bearings

Cage description	Stamped steel, ball centred	Machined brass, ball centred	Machined steel, ball centred
Suffix	-	M	F

Fig. 6

Single direction bearing with a sphered housing washer

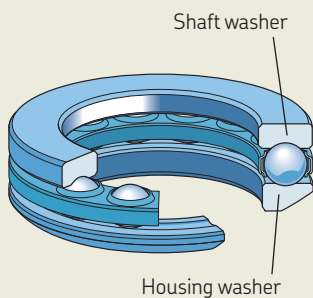
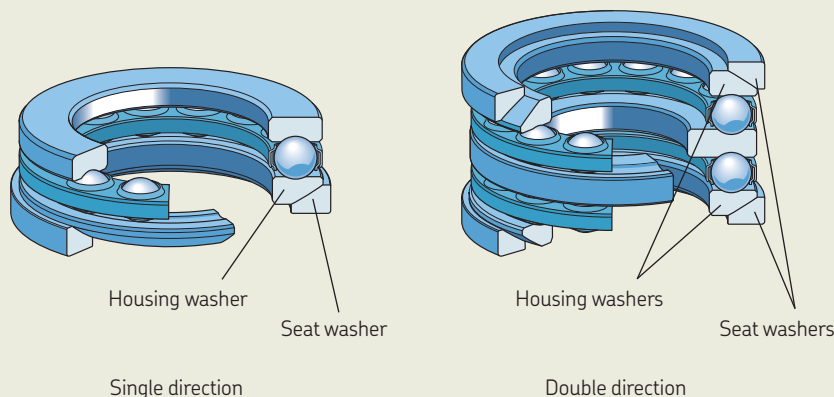

Fig. 7

Bearings with sphered housing washer(s) and sphered seat washer(s)



Bearing data

	Thrust ball bearings with flat housing washers	Thrust ball bearings with sphered housing washers
Dimension standards	ISO 104 Bearings in the BA series are not standardized.	ISO 20516
Tolerances	Normal P5 or P6 on request (single direction bearings only)	Normal
For additional information → page 35	Values: ISO 199 (table 10, page 46) Bearings in the BA series are not standardized.	
Permissible misalignment	Cannot tolerate any misalignment.	Accommodate only initial misalignment.

Loads

Minimum load	$F_{am} = A \left(\frac{n}{1\,000} \right)^2$	Symbols A minimum load factor (product tables, page 472) F _a axial load [kN] F _{am} minimum axial load [kN] n rotational speed [r/min] P equivalent dynamic bearing load [kN] P ₀ equivalent static bearing load [kN]
For additional information → page 106		
Equivalent dynamic bearing load		
P = F _a		
For additional information → page 91		
Equivalent static bearing load	P ₀ = F _a	
For additional information → page 105		

Temperature limits

The permissible operating temperature for thrust ball bearings can be limited by:

- the dimensional stability of the bearing washers and balls
- the cage
- the seat washer(s)
- the lubricant

Where temperatures outside the permissible range are expected, contact SKF.

Bearing washers and balls

Depending on their size, washers and balls of SKF thrust ball bearings are heat stabilized up to:

- 125 °C (260 °F) where $d \leq 300$ mm
- 150 °C (300 °F) where $d > 300$ mm

Cages

Steel and brass cages can be used at the same operating temperatures as the bearing washers and balls.

Seat washers

Seat washers are made of steel and can be used at the same operating temperatures as the bearing washers and balls.

Lubricants

For temperature limits of SKF greases, refer to *Selecting a suitable SKF grease*, [page 116](#).

When using lubricants not supplied by SKF, temperature limits should be evaluated according to the SKF traffic light concept ([page 117](#)).

Permissible speed

The speed ratings in the [product tables](#) indicate:

- the **reference speed**, which enables a quick assessment of the speed capabilities from a thermal frame of reference
- the **limiting speed**, which is a mechanical limit that should not be exceeded unless the bearing design and the application are adapted for higher speeds

For additional information, refer to *Operating temperature and speed*, [page 130](#).

Mounting

Where mounting a single direction thrust ball bearing, it is important to differentiate between the shaft washer and the housing washer. The bore of the shaft washer is ground and always smaller than the bore of the housing washer. The shaft washer should always be placed against a shaft step or fixed shaft component.

Designation system

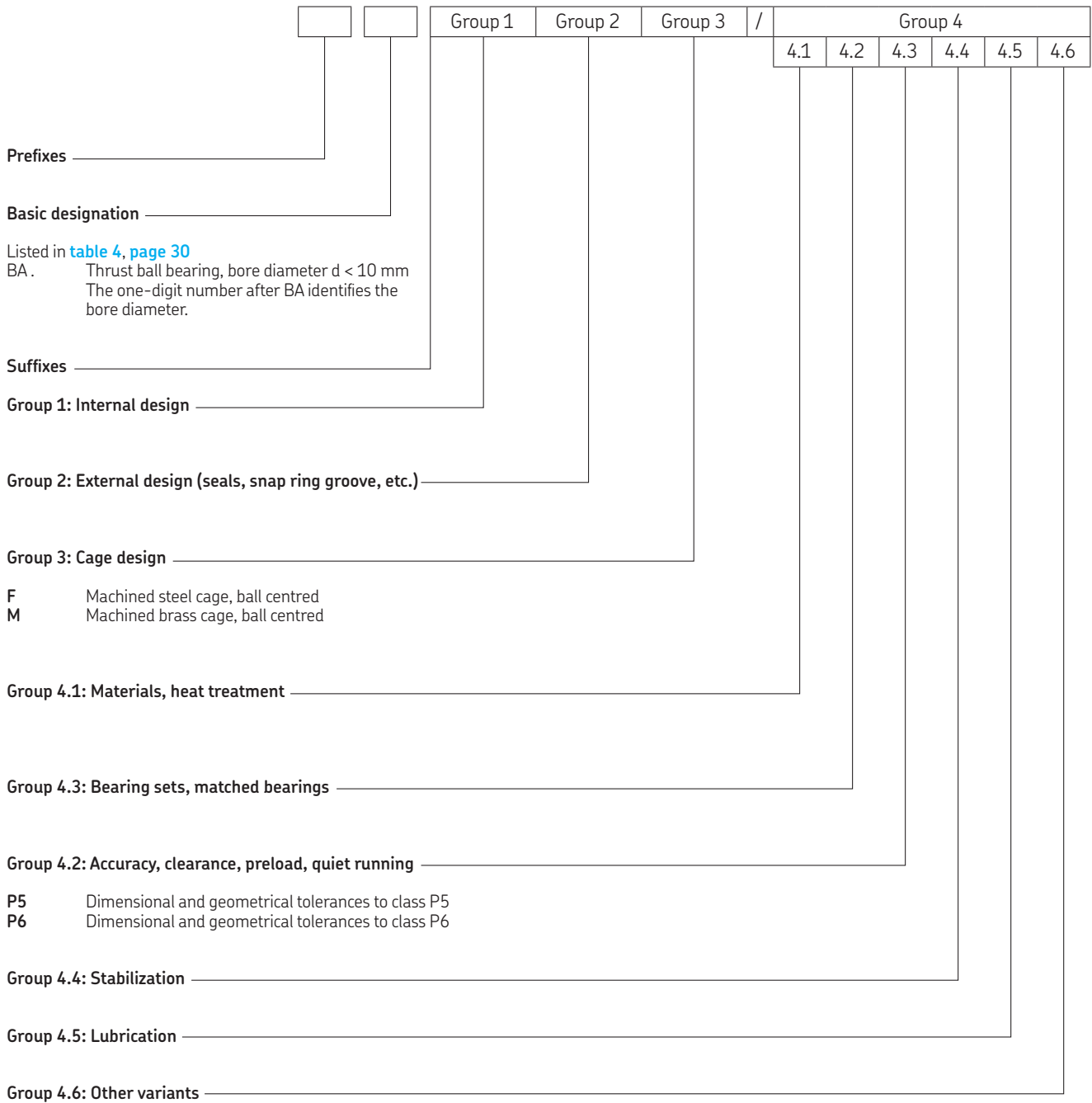

5.1 Single direction thrust ball bearings

d 3 – 35 mm

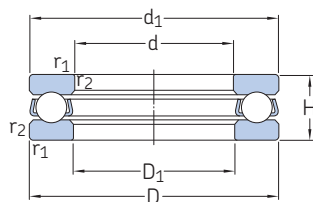

Principal dimensions			Basic load ratings		Fatigue load limit	Minimum load factor	Speed ratings		Mass	Designation
d	D	H	dynamic	static			Reference speed	Limiting speed		
mm			kN		kN	–	r/min		kg	–
3	8	3,5	0,806	0,72	0,027	0,000 003	26 000	36 000	0,0009	▶ BA 3
4	10	4	0,761	0,72	0,027	0,000 003	22 000	30 000	0,0015	▶ BA 4
5	12	4	0,852	0,965	0,036	0,000 005	20 000	28 000	0,0021	▶ BA 5
6	14	5	1,78	1,92	0,071	0,000 019	17 000	24 000	0,0035	▶ BA 6
7	17	6	2,51	2,9	0,108	0,000 044	14 000	19 000	0,0065	▶ BA 7
8	19	7	3,19	3,8	0,143	0,000 075	12 000	17 000	0,0091	▶ BA 8
9	20	7	3,12	3,8	0,143	0,000 075	12 000	16 000	0,01	▶ BA 9
10	24	9	9,95	15,3	0,56	0,0012	9 500	13 000	0,02	▶ 51100
	26	11	12,7	18,6	0,695	0,0018	8 000	11 000	0,03	▶ 51200
12	26	9	10,4	16,6	0,62	0,0014	9 000	13 000	0,022	▶ 51101
	28	11	13,3	20,8	0,765	0,0022	8 000	11 000	0,034	▶ 51201
15	28	9	10,6	18,3	0,67	0,0017	8 500	12 000	0,023	▶ 51102
	32	12	15,9	25	0,915	0,0038	7 000	10 000	0,046	▶ 51202
17	30	9	11,4	21,2	0,78	0,0023	8 500	12 000	0,025	▶ 51103
	35	12	16,3	27	1	0,0047	6 700	9 500	0,053	▶ 51203
20	35	10	15,1	29	1,08	0,0044	7 500	10 000	0,037	▶ 51104
	40	14	21,2	37,5	1,4	0,0085	6 000	8 000	0,083	▶ 51204
25	42	11	18,2	39	1,43	0,0079	6 300	9 000	0,056	▶ 51105
	47	15	26,5	50	1,86	0,015	5 300	7 500	0,11	▶ 51205
30	52	18	34,5	60	2,24	0,018	4 500	6 300	0,17	▶ 51305
	60	24	42,3	67	2,45	0,048	3 600	5 000	0,34	▶ 51405
30	47	11	19	43	1,6	0,0096	6 000	8 500	0,063	▶ 51106
	52	16	25,1	51	1,86	0,013	4 800	6 700	0,13	▶ 51206
35	60	21	35,8	65,5	2,4	0,026	3 800	5 300	0,26	▶ 51306
	70	28	70,2	122	4,5	0,097	3 000	4 300	0,52	▶ 51406
35	52	12	19,9	51	1,86	0,013	5 600	7 500	0,08	▶ 51107
	62	18	35,1	73,5	2,7	0,028	4 000	5 600	0,22	▶ 51207
35	68	24	49,4	96,5	3,55	0,048	3 400	4 800	0,39	▶ 51307
	80	32	76,1	137	5,1	0,15	2 600	3 600	0,79	▶ 51407

▶ Popular item

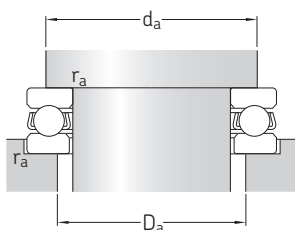

Dimensions **Abutment and fillet dimensions**

d	d ₁ ≈	D ₁ ≈	r _{1,2} min.	d _a min.	D _a max.	r _a max.
---	---------------------	---------------------	--------------------------	------------------------	------------------------	------------------------

mm

mm

3	7,8	3,2	0,15	5,8	5	0,15
4	9,8	4,2	0,15	7,5	6,5	0,15
5	11,8	5,2	0,15	8	9	0,15
6	13,8	6,2	0,2	11	9,5	0,2
7	16,8	7,2	0,2	12,5	11	0,2
8	18,8	8,2	0,3	14,5	12,5	0,3
9	19,8	9,2	0,3	15,5	13,5	0,3
10	24 26	11 12	0,3 0,6	19 20	15 16	0,3 0,6
12	26 28	13 14	0,3 0,6	21 22	17 18	0,3 0,6
15	28 32	16 17	0,3 0,6	23 25	20 22	0,3 0,6
17	30 35	18 19	0,3 0,6	25 28	22 24	0,3 0,6
20	35 40	21 22	0,3 0,6	29 32	26 28	0,3 0,6
25	42 47	26 27	0,6 0,6	35 38	32 34	0,6 0,6
	52 60	27 27	1 1	41 46	36 39	1 1
30	47 52	32 32	0,6 0,6	40 43	37 39	0,6 0,6
	60 70	32 32	1 1	48 54	42 46	1 1
35	52 62	37 37	0,6 1	45 51	42 46	0,6 1
	68 80	37 37	1 1,1	55 62	48 53	1 1

5.1 Single direction thrust ball bearings

d 40 – 75 mm

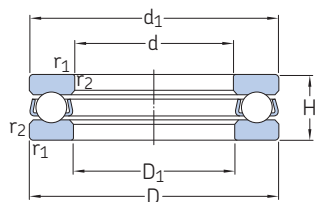

Principal dimensions			Basic load ratings		Fatigue load limit	Minimum load factor	Speed ratings		Mass	Designation
d	D	H	dynamic	static			Reference speed	Limiting speed		
mm			kN		kN	–	r/min		kg	–
40	60	13	25,5	63	2,32	0,02	5 000	7 000	0,12	► 51108
	68	19	44,2	96,5	3,6	0,058	3 800	5 300	0,28	► 51208
	78	26	61,8	122	4,5	0,077	3 000	4 300	0,53	► 51308
	90	36	95,6	183	6,8	0,26	2 400	3 400	1,1	► 51408
45	65	14	26,5	69,5	2,55	0,025	4 500	6 300	0,14	► 51109
	73	20	39	86,5	3,2	0,038	3 600	5 000	0,3	► 51209
	85	28	76,1	153	5,6	0,12	2 800	4 000	0,66	► 51309
	100	39	124	240	9	0,37	2 200	3 000	1,4	► 51409
50	70	14	27	75	2,8	0,029	4 300	6 300	0,16	► 51110
	78	22	49,4	116	4,3	0,069	3 400	4 500	0,37	► 51210
	95	31	81,9	170	6,3	0,19	2 600	3 600	0,94	► 51310
	110	43	159	340	12,5	0,6	2 000	2 800	2	► 51410
55	78	16	30,2	81,5	3	0,039	3 800	5 300	0,23	► 51111
	90	25	58,5	134	4,9	0,11	2 800	4 000	0,59	► 51211
	105	35	101	224	8,3	0,26	2 200	3 200	1,3	► 51311
	120	48	195	400	14,6	0,79	1 800	2 400	2,55	► 51411
60	85	17	41,6	122	4,55	0,077	3 600	5 000	0,27	► 51112
	95	26	59,2	140	5,1	0,12	2 800	3 800	0,65	► 51212
	110	35	101	224	8,3	0,26	2 200	3 000	1,35	► 51312
	130	51	199	430	16	0,96	1 600	2 200	3,1	► 51412 M
65	90	18	37,7	108	4	0,06	3 400	4 800	0,33	► 51113
	100	27	60,5	150	5,5	0,14	2 600	3 600	0,72	► 51213
	115	36	106	240	8,8	0,3	2 000	3 000	1,5	► 51313
	140	56	216	490	18	1,2	1 500	2 200	4	► 51413 M
70	95	18	40,3	120	4,4	0,074	3 400	4 500	0,35	► 51114
	105	27	62,4	160	5,85	0,16	2 600	3 600	0,79	► 51214
	125	40	135	320	11,8	0,53	1 900	2 600	2	► 51314
	150	60	234	550	19,3	1,6	1 400	2 000	5	► 51414 M
75	100	19	44,2	134	4,9	0,11	3 200	4 300	0,4	► 51115
	110	27	63,7	170	6,2	0,17	2 400	3 400	0,83	► 51215
	135	44	163	390	14	0,79	1 700	2 400	2,6	► 51315
	160	65	251	610	20,8	1,9	1 300	1 800	6,75	► 51415 M

► Popular item

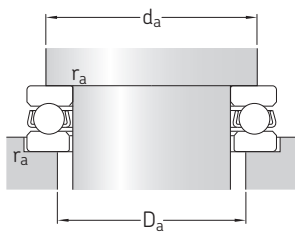

Dimensions				Abutment and fillet dimensions		
d	d_1 ≈	D_1 ≈	$r_{1,2}$ min.	d_a min.	D_a max.	r_a max.
mm				mm		
40	60	42	0,6	52	48	0,6
	68	42	1	57	51	1
	78	42	1	63	55	1
	90	42	1,1	70	60	1
45	65	47	0,6	57	53	0,6
	73	47	1	62	56	1
	85	47	1	69	61	1
	100	47	1,1	78	67	1
50	70	52	0,6	62	58	0,6
	78	52	1	67	61	1
	95	52	1,1	77	68	1
	110	52	1,5	86	74	1,5
55	78	57	0,6	69	64	0,6
	90	57	1	76	69	1
	105	57	1,1	85	75	1
	120	57	1,5	94	81	1,5
60	85	62	1	75	70	1
	95	62	1	81	74	1
	110	62	1,1	90	80	1
	130	62	1,5	102	88	1,5
65	90	67	1	80	75	1
	100	67	1	86	79	1
	115	67	1,1	95	85	1
	140	68	2	110	95	2
70	95	72	1	85	80	1
	105	72	1	91	84	1
	125	72	1,1	103	92	1
	150	73	2	118	102	2
75	100	77	1	90	85	1
	110	77	1	96	89	1
	135	77	1,5	111	99	1,5
	160	78	2	126	109	2

5.1 Single direction thrust ball bearings

d 80 – 140 mm

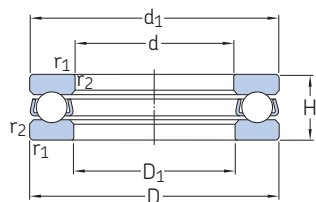

Principal dimensions			Basic load ratings		Fatigue load limit	Minimum load factor	Speed ratings		Mass	Designation
d	D	H	dynamic	static			Reference speed	Limiting speed		
mm			kN		kN	–	r/min		kg	–
80	105	19	44,9	140	5,1	0,12	3 000	4 300	0,42	► 51116
	115	28	76,1	208	7,65	0,22	2 400	3 400	0,91	► 51216
	140	44	159	390	13,7	0,79	1 700	2 400	2,7	► 51316
	170	68	302	750	25	2,3	1 200	1 700	7,95	► 51416 M
85	110	19	44,9	146	5,4	0,14	3 000	4 300	0,44	► 51117
	125	31	97,5	275	9,8	0,39	2 200	3 000	1,2	► 51217
	150	49	174	405	14	1,1	1 600	2 200	3,55	► 51317
	180	72	286	750	24	2,9	1 200	1 600	9,45	► 51417 M
90	120	22	59,2	208	7,5	0,22	2 600	3 800	0,67	► 51118
	135	35	112	290	10,4	0,55	2 000	2 800	1,7	► 51218
	155	50	182	440	14,6	1,3	1 500	2 200	3,8	► 51318
	190	77	307	815	25,5	3,5	1 100	1 500	11	► 51418 M
100	135	25	80,6	265	9,15	0,44	2 400	3 200	0,97	► 51120
	150	38	119	325	10,8	0,62	1 800	2 400	2,2	► 51220
	170	55	225	570	18,3	1,9	1 400	1 900	4,95	► 51320
	210	85	371	1 060	31,5	5,8	950	1 400	15	► 51420 M
110	145	25	83,2	285	9,5	0,52	2 200	3 200	1,05	► 51122
	160	38	125	365	11,6	0,79	1 700	2 400	2,4	► 51222
	190	63	281	815	24,5	3,2	1 200	1 700	7,85	► 51322 M
	230	95	410	1 220	34,5	7,7	900	1 300	20	► 51422 M
120	155	25	85,2	305	9,65	0,58	2 200	3 000	1,15	► 51124
	170	39	127	390	11,8	1	1 600	2 200	2,65	► 51224
	210	70	325	980	28,5	5	1 100	1 500	11	► 51324 M
	250	102	432	1 320	36	16	800	1 100	25,5	► 51424 M
130	170	30	119	440	13,4	0,94	1 900	2 600	1,85	► 51126
	190	45	186	585	17	1,8	1 400	2 000	4	► 51226
	225	75	358	1 140	32	6,8	1 000	1 400	13	► 51326 M
	270	110	520	1 730	45	16	750	1 000	32	► 51426 M
140	180	31	111	440	12,9	1	1 800	2 600	2,05	► 51128
	200	46	190	620	17,6	2	1 400	1 900	4,35	► 51228
	240	80	377	1 220	32,5	9,1	950	1 300	15,5	► 51328 M
	280	112	520	1 730	44	16	700	1 000	34,5	► 51428 M

► Popular item

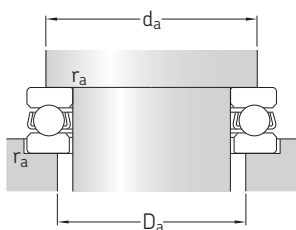

Dimensions				Abutment and fillet dimensions		
d	d ₁ ≈	D ₁ ≈	r _{1,2} min.	d _a min.	D _a max.	r _a max.
mm				mm		
80	105	82	1	95	90	1
	115	82	1	101	94	1
	140	82	1,5	116	104	1,5
	170	83	2,1	133	117	2
85	110	87	1	100	95	1
	125	88	1	109	101	1
	150	88	1,5	124	111	1,5
	177	88	2,1	141	124	2
90	120	92	1	108	102	1
	135	93	1,1	117	108	1
	155	93	1,5	129	116	1,5
	187	93	2,1	149	131	2
100	135	102	1	121	114	1
	150	103	1,1	130	120	1
	170	103	1,5	142	128	1,5
	205	103	3	165	145	2,5
110	145	112	1	131	124	1
	160	113	1,1	140	130	1
	187	113	2	158	142	2
	225	113	3	181	159	2,5
120	155	122	1	141	134	1
	170	123	1,1	150	140	1
	205	123	2,1	173	157	2
	245	123	4	197	173	3
130	170	132	1	154	146	1
	187	133	1,5	166	154	1,5
	220	134	2,1	186	169	2
	265	134	4	213	187	3
140	178	142	1	164	156	1
	197	143	1,5	176	164	1,5
	235	144	2,1	199	181	2
	275	144	4	223	197	3

5.1 Single direction thrust ball bearings

d 150 – 340 mm

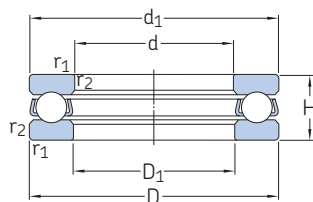

Principal dimensions			Basic load ratings		Fatigue load limit	Minimum load factor	Speed ratings		Mass	Designation
d	D	H	dynamic	static			Reference speed	Limiting speed		
mm			kN		kN	–	r/min		kg	–
150	190	31	111	440	12,5	1	1 700	2 400	2,2	► 51130 M
	215	50	238	800	22	3,3	1 300	1 800	6,1	► 51230 M
	250	80	390	1 290	34	10	900	1 300	16,5	► 51330 M
	300	120	559	1 960	48	20	670	950	42,5	► 51430 M
160	200	31	112	465	12,9	1,1	1 700	2 400	2,35	► 51132 M
	225	51	238	830	22,4	3,8	1 200	1 700	6,55	► 51232 M
	270	87	449	1 660	41,5	14	850	1 200	21	► 51332 M
170	215	34	133	540	14,3	1,5	1 600	2 200	3,3	► 51134 M
	240	55	270	930	24	5,4	1 200	1 700	8,15	► 51234 M
	280	87	468	1 760	43	16	800	1 100	22	► 51334 M
180	225	34	135	570	15	1,7	1 500	2 200	3,5	► 51136 M
	250	56	302	1 120	28,5	6,1	1 200	1 600	8,6	► 51236 M
	300	95	520	2 000	47,5	21	750	1 100	28,5	► 51336 M
190	240	37	172	710	18	2,6	1 400	2 000	4,05	► 51138 M
	270	62	332	1 270	31	8,4	1 100	1 600	12	► 51238 M
	320	105	559	2 200	51	30	700	950	36,5	► 51338 M
200	250	37	168	710	17,6	2,6	1 400	1 900	4,25	► 51140 M
	280	62	338	1 320	31,5	9,1	1 100	1 500	12	► 51240 M
	340	110	624	2 600	58,5	35	630	900	44,5	► 51340 M
220	270	37	178	800	19	3,3	1 300	1 900	4,6	► 51144 M
	300	63	358	1 460	33,5	11	950	1 300	13	► 51244 M
240	300	45	234	1 040	23,6	5,6	1 100	1 600	7,55	► 51148 M
	340	78	449	1 960	42,5	21	800	1 100	23	► 51248 M
260	320	45	238	1 100	24	6,3	1 100	1 500	8,1	► 51152 M
	360	79	488	2 240	46,5	24	750	1 100	25	► 51252 M
280	350	53	319	1 460	30,5	11	950	1 300	12	► 51156 M
	380	80	488	2 320	47,5	28	750	1 000	26,5	► 51256 M
300	380	62	364	1 760	35,5	16	850	1 200	17,5	► 51160 M
	420	95	585	3 000	57	47	630	850	42	► 51260 M
320	400	63	371	1 860	36,5	18	800	1 100	19	► 51164 M
	440	95	572	3 000	56	47	600	800	45,5	► 51264 F
	440	95	572	3 000	56	47	600	800	45	► 51264 M
340	420	64	377	1 960	37,5	20	800	1 100	20,5	► 51168 M
	460	96	605	3 200	25,5	53	600	800	48,5	► 51268 F

► Popular item

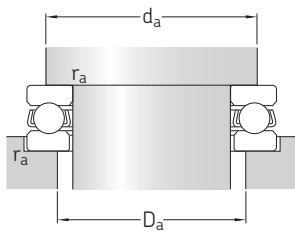

Dimensions				Abutment and fillet dimensions		
d	d ₁ ≈	D ₁ ≈	r _{1,2} min.	d _a min.	D _a max.	r _a max.
mm				mm		
150	188	152	1	174	166	1
	212	153	1,5	189	176	1,5
	245	154	2,1	209	191	2
	295	154	4	239	211	3
160	198	162	1	184	176	1
	222	163	1,5	199	186	1,5
	265	164	3	225	205	2,5
170	213	172	1,1	197	188	1
	237	173	1,5	212	198	1,5
	275	174	3	235	215	2,5
180	222	183	1,1	207	198	1
	245	183	1,5	222	208	1,5
	295	184	3	251	229	2,5
190	237	193	1,1	220	210	1
	265	194	2	238	222	2
	315	195	4	267	243	3
200	247	203	1,1	230	220	1
	275	204	2	248	232	2
	335	205	4	283	257	3
220	267	223	1,1	250	240	1
	295	224	2	268	252	2
240	297	243	1,5	276	264	1,5
	335	244	2,1	299	281	2
260	317	263	1,5	296	284	1,5
	355	264	2,1	319	301	2
280	347	283	1,5	322	308	1,5
	375	284	2,1	339	321	2
300	376	304	2	348	332	2
	415	304	3	371	349	2,5
320	396	324	2	368	352	2
	435	325	3	391	369	2,5
	435	325	3	391	369	2,5
340	416	344	2	388	372	2
	455	345	3	411	389	2,5

5.1 Single direction thrust ball bearings

d 360 – 670 mm

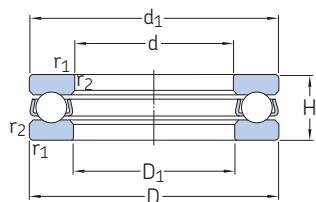

Principal dimensions			Basic load ratings		Fatigue load limit	Minimum load factor	Speed ratings		Mass	Designation
d	D	H	dynamic	static			Reference speed	Limiting speed		
mm			kN		kN	–	r/min		kg	–
360	440	65	390	2 080	38	22	750	1 100	22	51172 F
	500	110	741	4 150	73,5	90	500	700	70	51272 F
380	460	65	397	2 200	40	25	750	1 000	23	51176 F
	520	112	728	4 150	72	90	500	700	73	51276 F
400	480	65	403	2 280	40,5	27	700	1 000	24	51180 F
420	500	65	410	2 400	41,5	30	700	1 000	25,5	51184 F
440	540	80	527	3 250	55	55	600	850	42	51188 F
460	560	80	527	3 250	54	55	600	800	43,5	51192 F
480	580	80	540	3 550	56	66	560	800	45,5	51196 F
500	600	80	553	3 600	57	67	560	800	47	511/500 F
530	640	85	650	4 400	68	100	530	750	58,5	511/530 F
560	670	85	650	4 650	68	110	500	700	61	511/560 F
600	710	85	663	4 800	69,5	120	500	700	65	511/600 F
630	750	95	728	5 400	76,5	150	450	630	84	511/630 F
670	800	105	852	6 700	91,5	230	400	560	105	511/670 F
	800	105	852	6 700	91,5	230	400	560	105	511/670 M

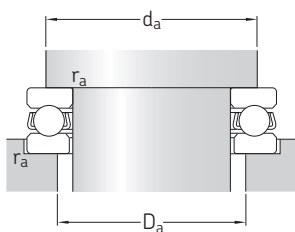

Dimensions				Abutment and fillet dimensions		
d	d_1 ≈	D_1 ≈	$r_{1,2}$ min.	d_a min.	D_a max.	r_a max.
mm				mm		
360	436	364	2	408	392	2
	495	365	4	443	417	3
380	456	384	2	428	412	2
	515	385	4	463	437	3
400	476	404	2	448	432	2
420	496	424	2	468	452	2
440	536	444	2,1	499	481	2
460	556	464	2,1	519	501	2
480	576	484	2,1	539	521	2
500	596	504	2,1	559	541	2
530	636	534	3	595	575	2,5
560	666	564	3	625	606	2,5
600	706	604	3	665	645	2,5
630	746	634	3	701	679	2,5
670	795	675	4	747	723	3
	795	675	4	747	723	3

5.2 Single direction thrust ball bearings with a sphered housing washer

d 12 – 75 mm

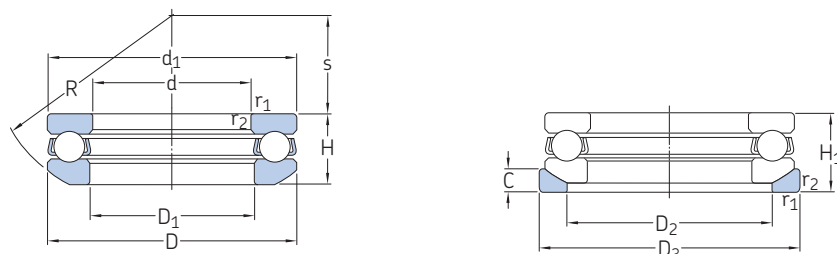

Principal dimensions			Basic load ratings		Fatigue load limit	Minimum load factor	Speed ratings		Mass Bearing + washer	Designations	
d	D	H ₁	dynamic	static			Reference speed	Limiting speed		Bearing	Seat washer
mm			kN	C ₀	P _u	A	r/min		kg	–	
12	28	13	13,3	20,8	0,765	0,0022	8 000	11 000	0,045	► 53201	U 201
15	32	15	15,9	25	0,915	0,0038	7 000	10 000	0,063	► 53202	U 202
17	35	15	16,3	27	1	0,0047	6 700	9 500	0,071	► 53203	U 203
20	40	17	21,2	37,5	1,4	0,0085	5 600	8 000	0,1	► 53204	U 204
25	47	19	26,5	50	1,86	0,015	5 000	7 000	0,15	► 53205	U 205
30	52	20	25,1	51	1,86	0,013	4 500	6 300	0,18	► 53206	U 206
	60	25	35,8	65,5	2,4	0,026	3 800	5 300	0,33	► 53306	U 306
35	62	22	35,1	73,5	2,7	0,028	4 000	5 600	0,28	► 53207	U 207
	68	28	49,4	96,5	3,55	0,048	3 200	4 500	0,46	► 53307	U 307
40	68	23	44,2	96,5	3,6	0,058	3 600	5 300	0,35	► 53208	U 208
	78	31	61,8	122	4,5	0,077	2 800	4 000	0,67	► 53308	U 308
	90	42	95,6	183	6,8	0,26	2 400	3 200	1,35	53408	U 408
45	73	24	39	86,5	3,2	0,038	3 400	4 800	0,39	► 53209	U 209
	85	33	76,1	153	5,6	0,12	2 600	3 800	0,83	► 53309	U 309
50	78	26	49,4	116	4,3	0,069	3 200	4 500	0,47	► 53210	U 210
	95	37	81,9	170	6,3	0,19	2 400	3 400	1,2	► 53310	U 310
	110	50	159	340	12,5	0,6	1 900	2 600	2,3	53410	U 410
55	90	30	58,5	134	4,9	0,11	2 800	3 800	0,75	► 53211	U 211
	105	42	101	224	8,3	0,26	2 200	3 000	1,7	► 53311	U 311
	120	55	195	400	14,6	0,79	1 700	2 400	3,1	53411	U 411
60	95	31	59,2	140	5,1	0,12	2 600	3 600	0,82	► 53212	U 212
	110	42	101	224	8,3	0,26	2 000	3 000	1,7	► 53312	U 312
	130	58	199	430	16	0,96	1 600	2 200	3,8	53412 M	U 412
65	100	32	60,5	150	5,5	0,14	2 600	3 600	0,91	► 53213	U 213
	115	43	106	240	8,8	0,3	2 000	2 800	1,9	► 53313	U 313
70	105	32	62,4	160	5,85	0,16	2 600	3 600	0,97	► 53214	U 214
	125	48	135	320	11,8	0,53	1 800	2 600	2,5	► 53314	U 314
	150	69	234	550	19,3	1,6	1 400	2 000	6,5	53414 M	U 414
75	110	32	63,7	170	6,2	0,17	2 400	3 400	1	► 53215	U 215
	135	52	163	390	14	0,79	1 700	2 400	3,2	► 53315	U 315
	160	75	251	610	20,8	1,9	1 300	1 800	8,1	53415 M	U 415

► Popular item

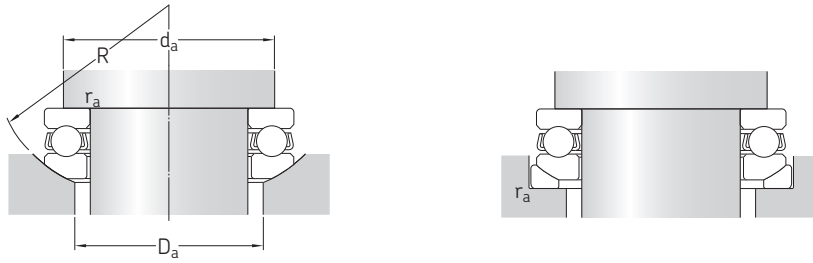

Dimensions										Abutment and fillet dimensions		
d	d ₁ ≈	D ₁ ≈	D ₂	D ₃	H	C	R	s	r _{1,2} min.	d _a min.	D _a max.	r _a max.
mm										mm		
12	28	14	20	30	11,4	3,5	25	11,5	0,6	22	20	0,6
15	32	17	24	35	13,3	4	28	12	0,6	25	24	0,6
17	35	19	26	38	13,2	4	32	16	0,6	28	26	0,6
20	40	22	30	42	14,7	5	36	18	0,6	32	30	0,6
25	47	27	36	50	16,7	5,5	40	19	0,6	38	36	0,6
30	52	32	42	55	17,8	5,5	45	22	0,6	43	42	0,6
	60	32	45	62	22,6	7	50	22	1	48	45	1
35	62	37	48	65	19,9	7	50	24	1	51	48	1
	68	37	52	72	25,6	7,5	56	24	1	55	52	1
40	68	42	55	72	20,3	7	56	28,5	1	57	55	1
	78	42	60	82	28,5	8,5	64	28	1	63	60	1
	90	42	65	95	38,2	12	72	26	1,1	70	65	1
45	73	47	60	78	21,3	7,5	56	26	1	62	60	1
	85	47	65	90	30,1	10	64	25	1	69	65	1
50	78	52	62	82	23,5	7,5	64	32,5	1	67	62	1
	95	52	72	100	34,3	11	72	28	1,1	77	72	1
	110	52	80	115	45,6	14	90	35	1,5	86	80	1,5
55	90	57	72	95	27,3	9	72	35	1	76	72	1
	105	57	80	110	39,3	11,5	80	30	1,1	85	80	1
	120	57	88	125	50,5	15,5	90	28	1,5	94	88	1,5
60	95	62	78	100	28	9	72	32,5	1	81	78	1
	110	62	85	115	38,3	11,5	90	41	1,1	90	85	1
	130	62	95	135	54	16	100	34	1,5	102	95	1
65	100	67	82	105	28,7	9	80	40	1	86	82	1
	115	67	90	120	39,4	12,5	90	38,5	1,1	95	90	1
70	105	72	88	110	27	9	80	38	1	91	88	1
	125	72	98	130	44,2	13	100	43	1,1	103	98	1
	150	73	110	155	63,6	19,5	112	34	2	118	110	2
75	110	77	92	115	28,3	9,5	90	49	1	96	92	1
	135	77	105	140	48,1	15	100	37	1,5	111	105	1
	160	78	115	165	69	21	125	42	2	126	115	2

5.2 Single direction thrust ball bearings with a sphered housing washer

d 80 – 140 mm

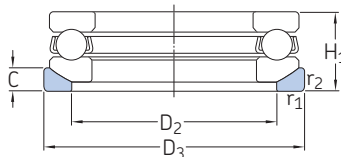
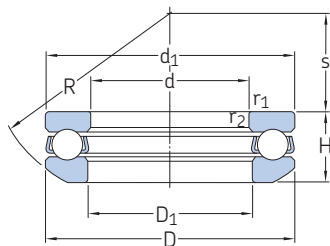

Principal dimensions			Basic load ratings		Fatigue load limit	Minimum load factor	Speed ratings		Mass Bearing + washer	Designations	
d	D	H ₁	dynamic	static			Reference speed	Limiting speed		Bearing	Seat washer
mm			kN		kN	–	r/min		kg	–	
80	115	33	76,1	208	7,65	0,22	2 400	3 200	1,1	▶ 53216	U 216
	140	52	159	390	13,7	0,79	1 600	2 200	3,2	▶ 53316	U 316
85	125	37	97,5	275	9	0,39	2 000	3 000	1,5	▶ 53217	U 217
	150	58	174	405	14	1,1	1 500	2 000	4,35	▶ 53317	U 317
90	135	42	112	290	10,4	0,55	1 900	2 600	2,1	▶ 53218	U 218
	155	59	182	440	14,6	1,3	1 400	2 000	4,7	▶ 53318	U 318
	190	88	307	815	25,5	3,5	1 100	1 500	13	▶ 53418 M	U 418
100	150	45	119	325	10,8	0,62	1 700	2 400	2,7	▶ 53220	U 220
	170	64	225	570	18,3	1,9	1 300	1 800	5,95	▶ 53320	U 320
	210	98	371	1 060	31,5	5,8	950	1 300	18	▶ 53420 M	U 420
110	160	45	125	365	11,6	0,79	1 700	2 400	2,9	▶ 53222	U 222
	190	72	281	815	24,5	3,2	1 100	1 600	9,1	▶ 53322 M	U 322
120	170	46	127	390	11,8	1	1 500	2 200	3,2	▶ 53224	U 224
	210	80	325	980	28,5	5	1 000	1 400	12,5	▶ 53324 M	U 324
130	190	53	186	585	17	1,8	1 300	1 800	4,85	▶ 53226	U 226
140	200	55	190	620	17,6	2	1 300	1 800	5,45	▶ 53228	U 228

▶ Popular item

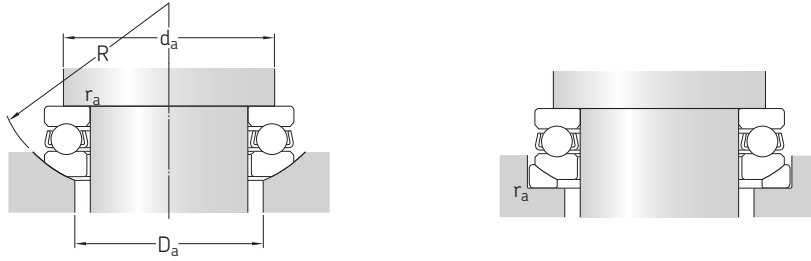

Dimensions										Abutment and fillet dimensions		
d	d ₁ ≈	D ₁ ≈	D ₂	D ₃	H	C	R	s	r _{1,2} min.	d _a min.	D _a max.	r _a max.
mm										mm		
80	115	82	98	120	29,5	10	90	46	1	101	98	1
	140	82	110	145	47,6	15	112	50	1,5	116	110	1
85	125	88	105	130	33,1	11	100	52	1	109	105	1
	150	88	115	155	53,1	17,5	112	43	1,5	124	115	1
90	135	93	110	140	38,5	13,5	100	45	1,1	117	110	1
	155	93	120	160	54,6	18	112	40	1,5	129	120	1
	187	93	140	195	81,2	25,5	140	40	2,1	133	140	2
100	150	103	125	155	40,9	14	112	52	1,1	130	125	1
	170	103	135	175	59,2	18	125	46	1,5	142	135	1
	205	103	155	220	90	27	160	50	3	165	155	2
110	160	113	135	165	40,2	14	125	65	1,1	140	135	1
	187	113	150	195	67,2	20	140	51	2	140	150	1
120	170	123	145	175	40,8	15	125	61	1,1	150	145	1
	205	123	165	220	74,1	22	160	63	2,1	173	165	1
130	187	133	160	195	47,9	17	140	67	1,5	166	160	1
140	197	143	170	210	48,6	17	160	87	1,5	176	170	1

5.3 Double direction thrust ball bearings

d 10 – 65 mm

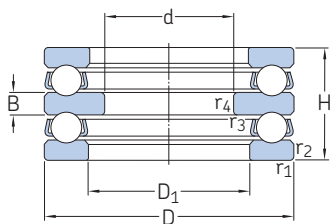

Principal dimensions			Basic load ratings		Fatigue load limit	Minimum load factor	Speed ratings		Mass	Designation
d	D	H	dynamic	static			Reference speed	Limiting speed		
mm			C	C ₀	P _u	A	r/min		kg	–
10	32	22	15,9	25	0,915	0,0038	5 300	7 500	0,081	► 52202
15	40	26	21,2	37,5	1,4	0,0085	4 300	6 000	0,15	► 52204
20	47	28	26,5	50	1,86	0,015	3 800	5 300	0,22	► 52205
	52	34	34,5	60	2,24	0,018	3 200	4 500	0,33	► 52305
	70	52	70,2	122	4,5	0,097	2 200	3 200	1	52406
25	52	29	25,1	51	1,86	0,013	3 600	5 000	0,25	► 52206
	60	38	35,8	65,5	2,4	0,026	2 800	4 000	0,47	► 52306
	80	59	76,1	137	5,1	0,15	2 000	2 800	1,45	52407
30	62	34	35,1	73,5	2,7	0,028	3 000	4 300	0,41	► 52207
	68	36	44,2	96,5	3,6	0,058	2 800	3 800	0,55	► 52208
	68	44	49,4	96,5	3,55	0,048	2 400	3 400	0,68	► 52307
	78	49	61,8	122	4,5	0,077	2 200	3 000	1,05	► 52308
35	90	65	95,6	183	6,8	0,26	1 800	2 400	2,05	52408
	73	37	39	86,5	3,2	0,038	2 600	3 600	0,6	► 52209
	85	52	76,1	153	5,6	0,12	2 000	2 800	1,25	► 52309
40	100	72	124	240	9	0,37	1 600	2 200	2,7	52409
	78	39	49,4	116	4,3	0,069	2 400	3 400	0,71	► 52210
	95	58	81,9	170	6,3	0,19	1 800	2 600	1,75	► 52310
45	90	45	58,5	134	4,9	0,11	2 200	3 000	1,1	► 52211
	105	64	101	224	8,3	0,26	1 600	2 200	2,4	► 52311
	120	87	195	400	14,6	0,79	1 300	1 800	4,7	52411
50	95	46	59,2	140	5,1	0,12	2 000	2 800	1,2	► 52212
	110	64	101	224	8,3	0,26	1 600	2 200	2,55	► 52312
	130	93	199	430	16	0,96	1 200	1 700	6,35	52412 M
55	100	47	60,5	150	5,5	0,14	2 000	2 800	1,35	► 52213
	105	47	62,4	160	5,85	0,16	1 900	2 600	1,5	► 52214
	115	64	106	240	8,8	0,3	1 600	2 200	2,75	52313
	125	72	135	320	11,8	0,53	1 400	2 000	3,65	52314
60	250	107	234	550	19,3	1,6	800	1 100	9,7	52414 M
	110	47	63,7	170	6,2	0,17	1 900	2 600	1,55	► 52215
65	135	79	163	390	14	0,79	1 300	1 800	4,8	52315
	115	48	76,1	208	7,65	0,22	2 400	3 400	1,7	► 52216
	140	79	159	390	13,7	0,79	1 300	1 800	4,95	52316

► Popular item

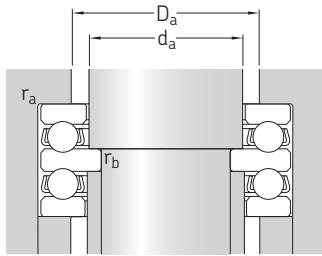

Dimensions					Abutment and fillet dimensions			
d	D ₁ ≈	B	r _{1,2} min.	r _{3,4} min.	d _a	D _a max.	r _a max.	r _b max.
mm					mm			
10	17	5	0,6	0,3	15	22	0,6	0,3
15	22	6	0,6	0,3	20	28	0,6	0,3
20	27	7	0,6	0,3	25	34	0,6	0,3
	27	8	1	0,3	25	36	1	0,3
	32	12	1	0,6	30	46	1	0,6
25	30	7	0,6	0,3	30	39	0,6	0,3
	32	9	1	0,3	30	42	1	0,3
	42	14	1,1	0,6	35	53	1	0,6
30	37	8	1	0,3	35	46	1	0,3
	42	9	1	0,6	40	51	1	0,6
	35	10	1	0,3	35	48	1	0,3
35	40	12	1	0,6	40	55	1	0,6
	42	15	1,1	0,6	40	60	1	0,6
	47	9	1	0,6	45	56	1	0,6
40	47	12	1	0,6	46	61	1	0,6
	47	17	1,1	0,6	45	67	1	0,6
	52	9	1	0,6	50	61	1	0,6
45	52	14	1,1	0,6	50	68	1	0,6
	57	10	1	0,6	55	69	1	0,6
	57	15	1,1	0,6	55	75	1	0,6
50	57	20	1,5	0,6	55	81	1,5	0,6
	62	10	1	0,6	60	74	1	0,6
	62	15	1,1	0,6	60	80	1	0,6
55	62	21	1,5	0,6	60	88	1,5	0,6
	67	10	1	0,6	65	79	1	0,6
	72	10	1	1	70	84	1	1
60	67	15	1,1	0,6	65	85	1	0,6
	72	16	1,1	1	70	92	1	1
	123	24	2	1	70	120	1,5	1
65	77	10	1	1	75	89	1	1
	77	18	1,5	1	75	99	1,5	1
65	82	10	1	0,6	80	94	1	1
	82	18	1,5	1	80	104	1	1

5.3 Double direction thrust ball bearings

d 70 – 150 mm

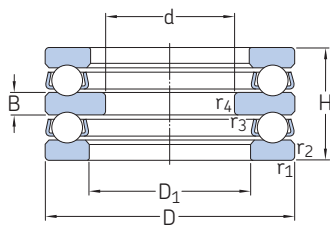

Principal dimensions			Basic load ratings		Fatigue load limit	Minimum load factor	Speed ratings		Mass	Designation
d	D	H	dynamic	static			Reference speed	Limiting speed		
mm			kN		kN	–	r/min		kg	–
70	125	55	97,5	275	9,8	0,39	1 600	2 200	2,4	▶ 52217
75	135	62	112	290	116	0,55	1 500	2 000	3,2	▶ 52218
85	150	67	119	325	10,8	0,62	1 300	1 800	4,2	▶ 52220
	170	97	225	570	18,3	1,9	1 000	1 400	8,95	▶ 52320
95	160	67	125	365	11,6	0,79	1 300	1 800	4,65	52222
100	170	68	127	390	11,8	1	1 200	1 700	5,25	52224
110	190	80	182	585	16,6	1,8	1 100	1 500	8	▶ 52226
120	200	81	190	620	17,6	2	1 000	1 400	8,65	52228
130	215	89	238	800	22	3,3	950	1 300	11,5	52230 M
140	225	90	238	830	22,4	3,8	900	1 300	12	▶ 52232 M
150	240	97	270	930	24	5,4	850	1 200	15	▶ 52234 M
	250	98	302	1 120	28,5	6,1	800	1 100	16	52236 M

▶ Popular item

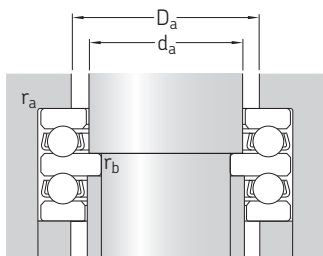

Dimensions					Abutment and fillet dimensions			
d	D_1 ≈	B	$r_{1,2}$ min.	$r_{3,4}$ min.	d_a	D_a max.	r_a max.	r_b max.
mm					mm			
70	88	12	1	1	85	101	1	1
75	93	14	1,1	1	90	108	1	1
85	103	15	1,1	1	100	120	1	1
	103	21	1,5	1	100	128	1	1
95	113	15	1,1	1	110	130	1	1
100	123	15	1,1	1,1	120	140	1	1
110	133	18	1,5	1,1	130	154	1,5	1
120	143	18	1,5	1,1	140	164	1,5	1
130	153	20	1,5	1,1	150	176	1,5	1
140	163	20	1,5	1,1	160	186	1,5	1
	173	21	1,5	1,1	170	198	1,5	1
150	183	21	1,5	2	180	208	1,5	2

5.4 Double direction thrust ball bearings with sphered housing washers

d 25 – 80 mm

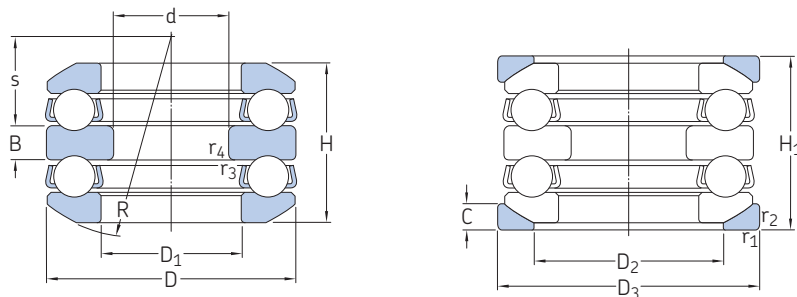

Principal dimensions			Basic load ratings		Fatigue load limit	Minimum load factor	Speed ratings		Mass Bearing + washer	Designations	
d	D	H ₁	dynamic	static			Reference speed	Limiting speed		Bearing	Seat washer
mm			kN	C ₀	P _u	A	r/min		kg	–	
25	60	46	35,8	65,5	2,4	0,026	2 800	3 800	0,58	▶	54306 U 306
30	62	42	35,1	73,5	2,7	0,028	2 800	4 000	0,53	▶	54207 U 207
	68	44	44,2	96,5	3,6	0,058	2 800	3 800	0,63		54208 U 208
	68	52	49,4	96,5	3,55	0,048	2 400	3 400	0,85	▶	54307 U 307
	78	59	61,8	122	4,5	0,077	2 200	3 000	1,15		54308 U 308
35	73	45	39	86,5	3,2	0,038	2 600	3 600	0,78		54209 U 209
	85	62	76,1	153	5,6	0,12	1 900	2 800	1,6	▶	54309 U 309
	100	86	124	240	9	0,37	1 500	2 000	3		54409 U 409
40	95	70	81,9	170	6,3	0,19	1 700	2 400	2,3		54310 U 310
	110	92	148	305	11,4	0,6	1 400	1 900	4,45		54410 U 410
45	90	55	58,5	134	4,9	0,11	2 200	3 000	1,3		54211 U 211
50	110	78	101	224	8,3	0,26	1 500	2 200	2,9		54312 U 312
65	140	95	159	390	13,7	0,79	1 300	1 800	5,55		54316 U 316
	170	140	307	750	25	2,3	850	1 200	17,5		54416 M U 416
70	150	105	174	405	14	1,1	1 100	1 500	7,95	▶	54317 U 317
80	210	176	371	1 060	31,5	5,8	700	950	29		54420 M U 420

▶ Popular item

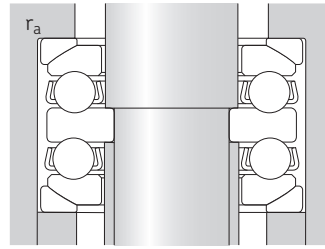
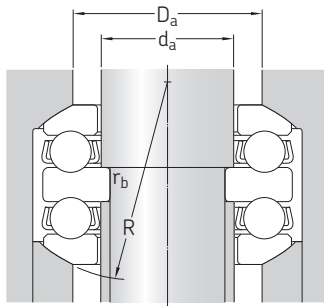

Dimensions											Abutment and fillet dimensions			
d	D ₁ ≈	D ₂	D ₃	H	B	C	R	s	r _{1,2} min.	r _{3,4} min.	d _a	D _a max.	r _a max.	r _b max.
mm											mm			
25	32	45	62	41,3	9	7	50	19,5	1	0,3	30	45	1	0,3
30	37	48	65	37,8	8	7	50	21	1	0,3	35	48	1	0,3
	42	55	72	38,6	9	7	56	25	1	0,6	40	55	1	0,6
	37	52	72	47,2	10	7,5	56	21	1	0,3	35	52	1	0,3
	42	60	82	54,1	12	8,5	64	23,5	1	0,6	40	60	1	0,6
35	47	60	78	39,6	9	7,5	56	23	1	0,6	45	60	1	0,6
	47	65	90	56,2	12	10	64	21	1	0,6	45	65	1	0,6
	47	72	105	78,9	17	12,5	80	23,5	1,1	0,6	45	72	1	0,6
40	52	72	100	64,7	14	11	72	23	1,1	0,6	50	72	1	0,6
	52	80	115	83,2	18	14	90	30	1,5	0,6	50	80	1,5	0,6
45	57	72	95	49,6	10	9	72	32,5	1	0,6	55	72	1	0,6
50	62	85	115	70,7	15	11,5	90	36,5	1,1	0,6	60	85	1	0,6
65	82	110	145	86,1	18	15	112	45,5	1,5	1	80	110	1,5	1
	83	125	175	128,5	27	22	125	30,5	2,1	1	80	125	2	1
70	88	115	155	95,2	19	17,5	112	39	1,5	1	85	115	1,5	1
80	103	155	220	159,9	33	27	160	43,5	3	1,1	100	155	2,5	1